



SCALA2



<http://qr.grundfos.com/i/scala2install>



PN10:
Max. 10 bar/1.0 MPa



- Voltage
- Ambient temperatur



Min./Max.
0 °C – 45 °C /
32 °F – 113 °F

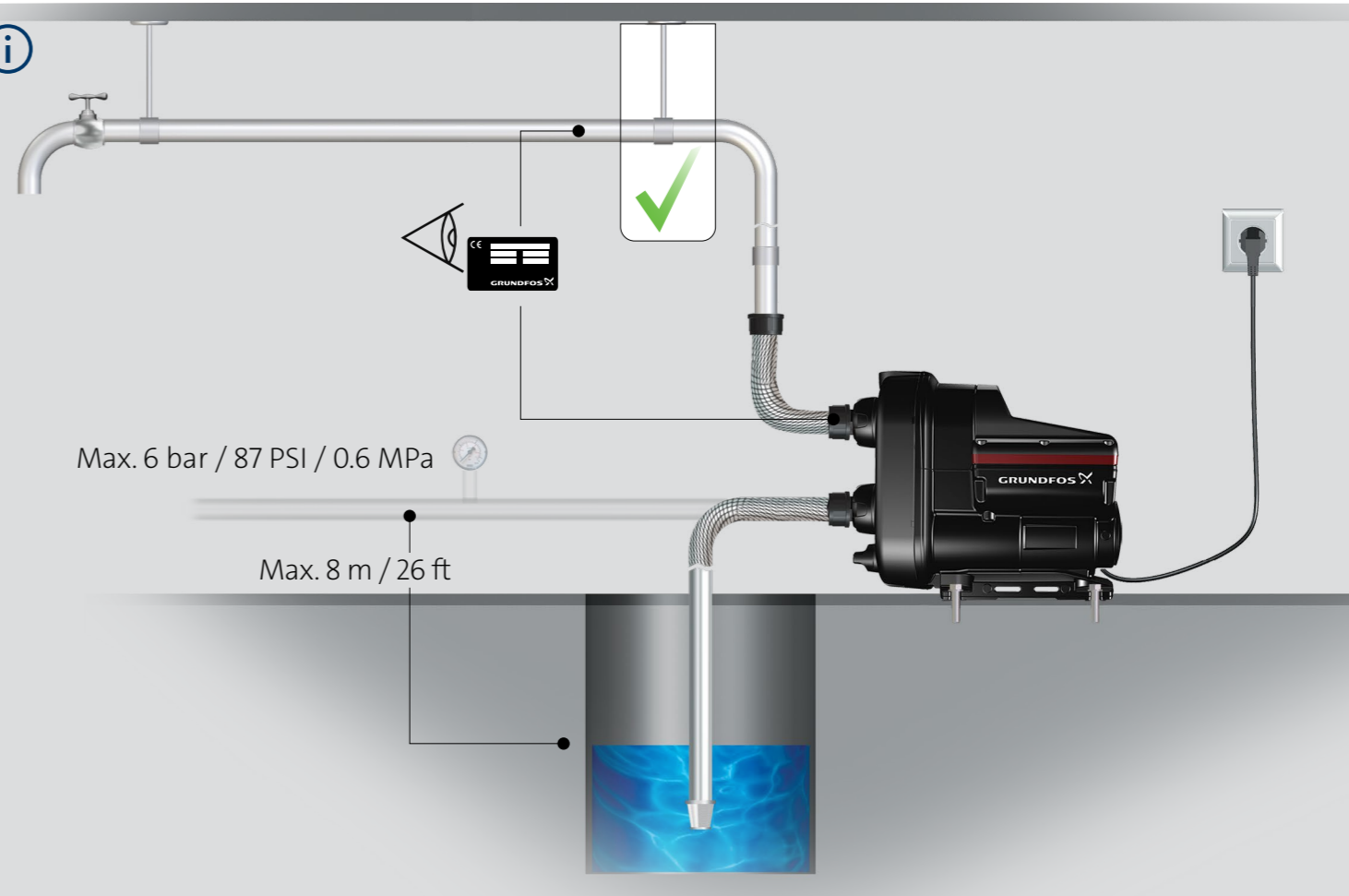
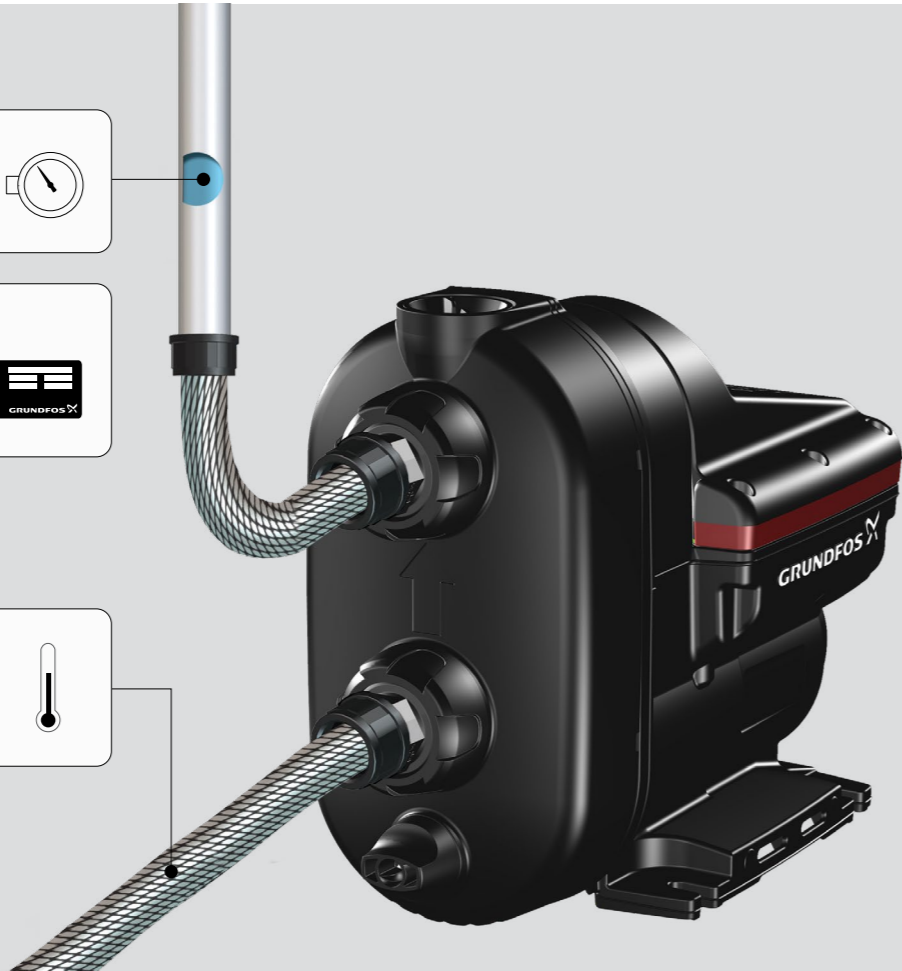

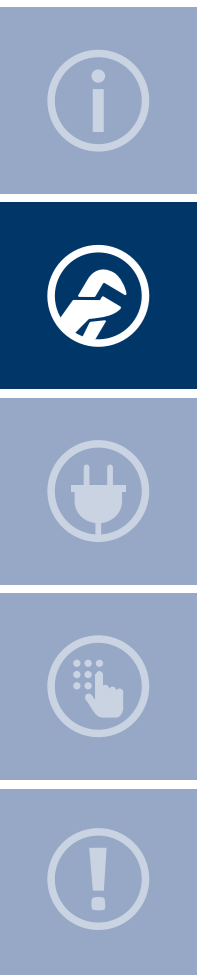

1

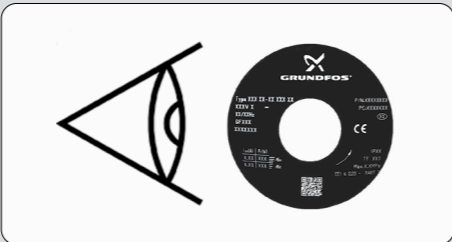

2

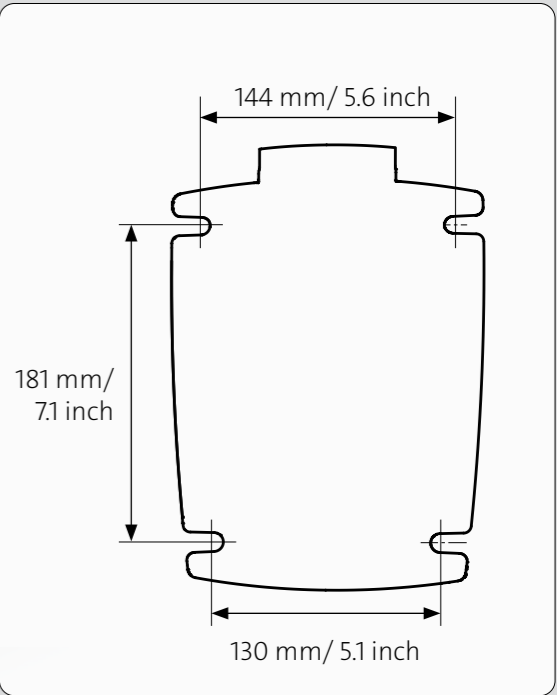

<http://qr.grundfos.com/i/scala2install>

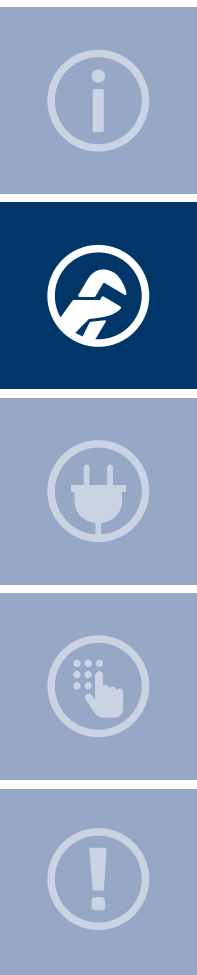

3

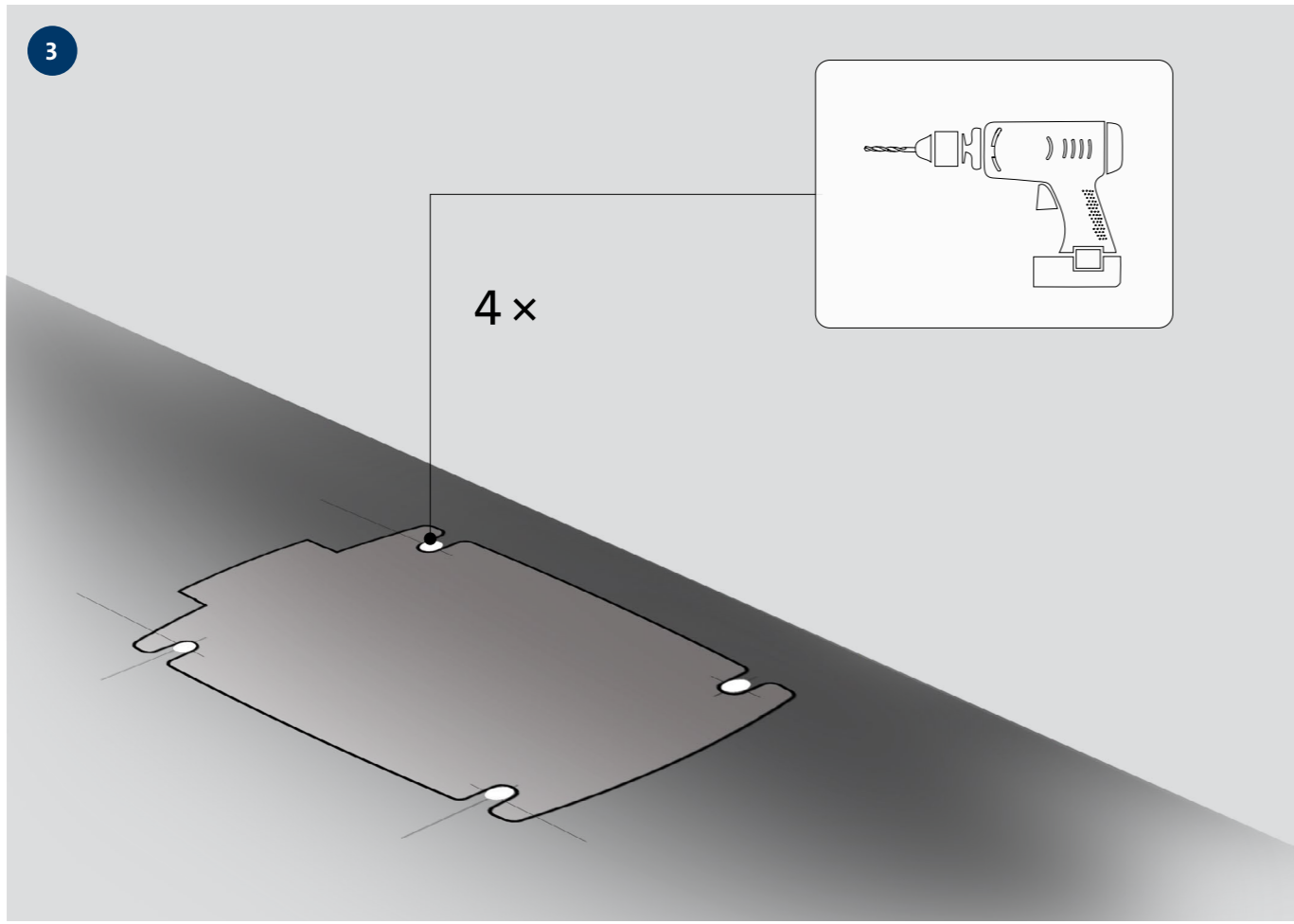

4

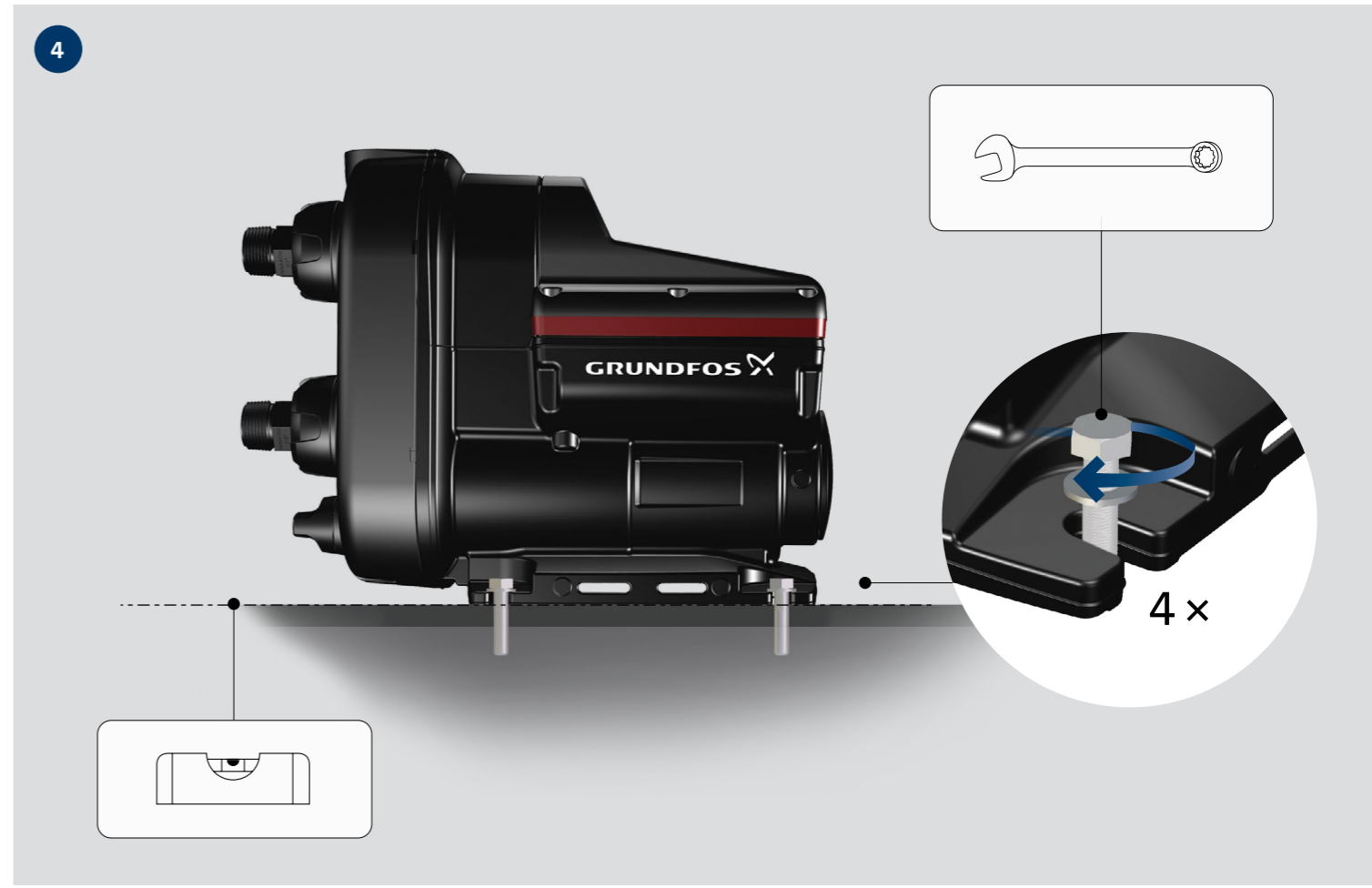

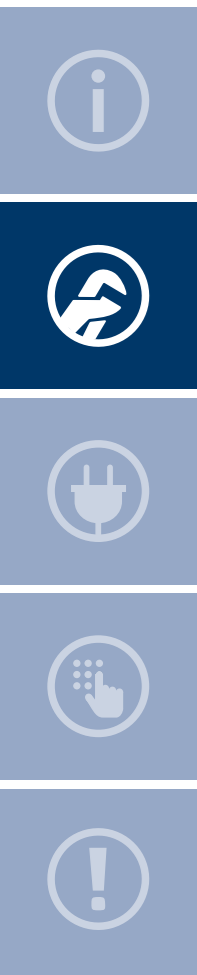

5

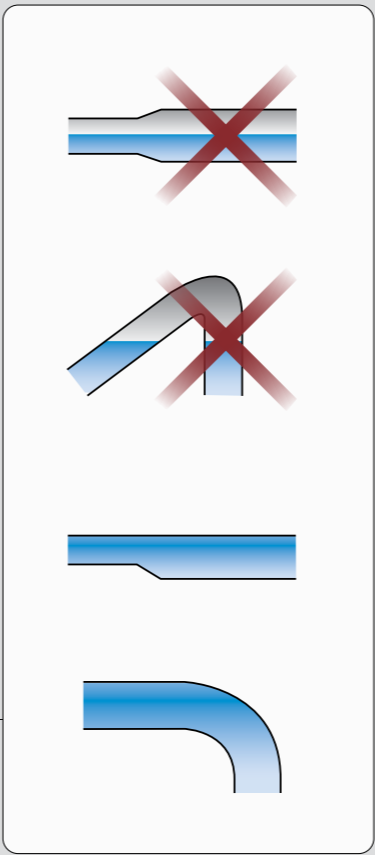
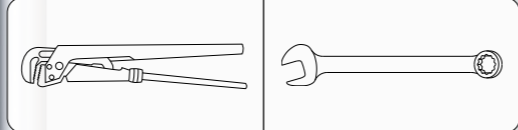
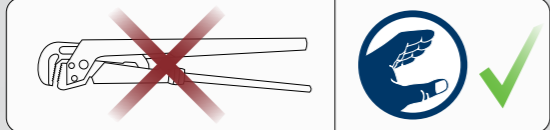

5A



5B



5C



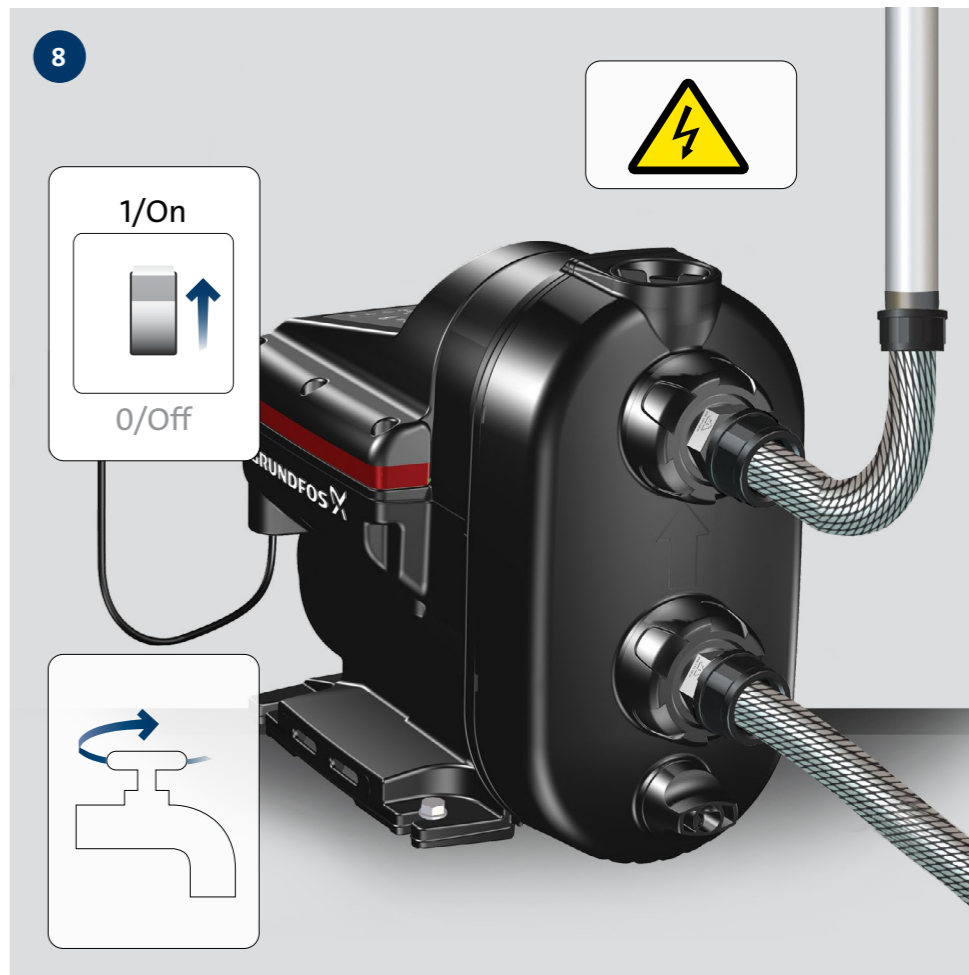
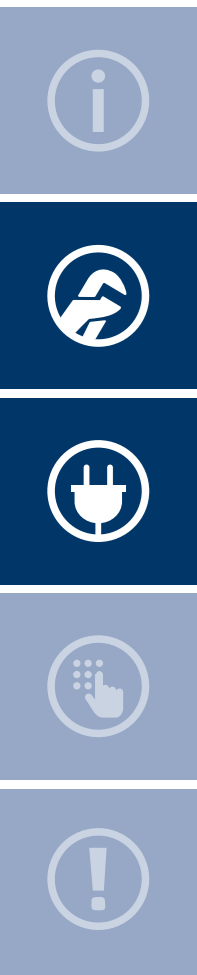

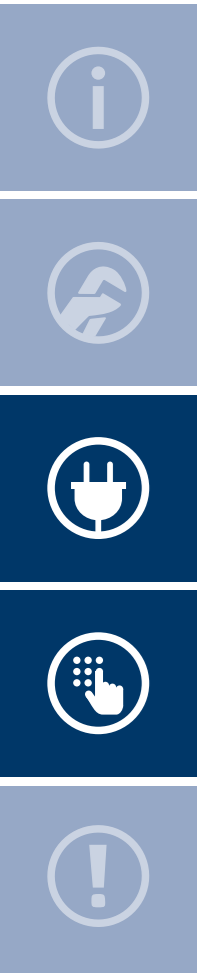

9

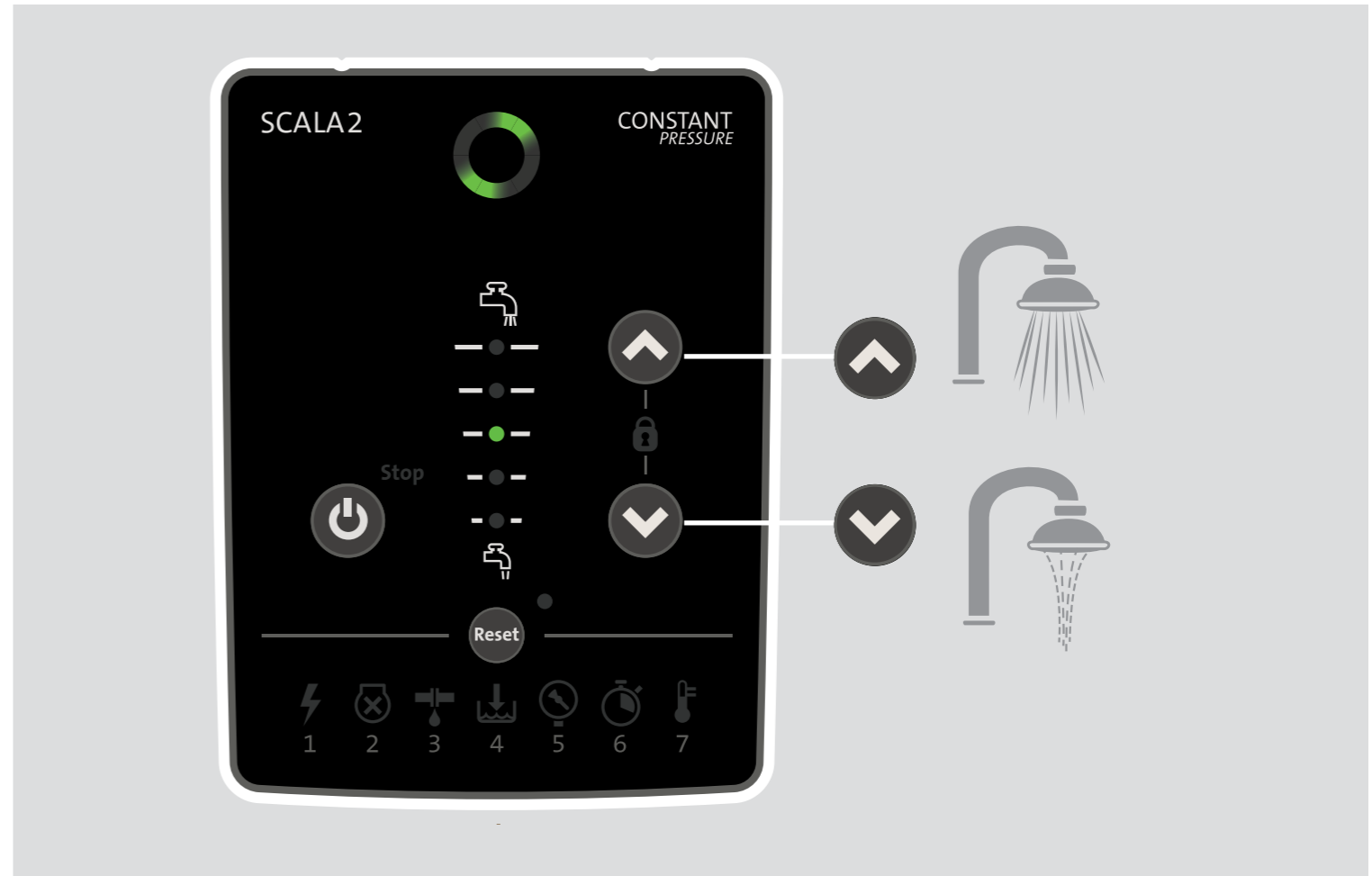
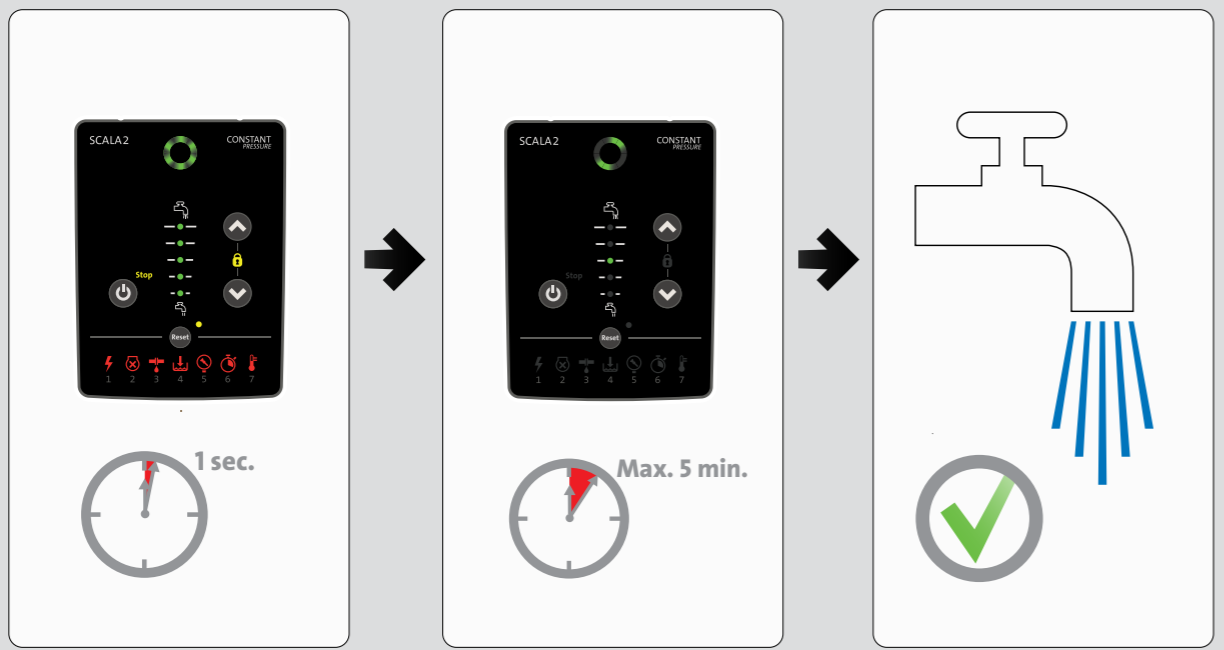

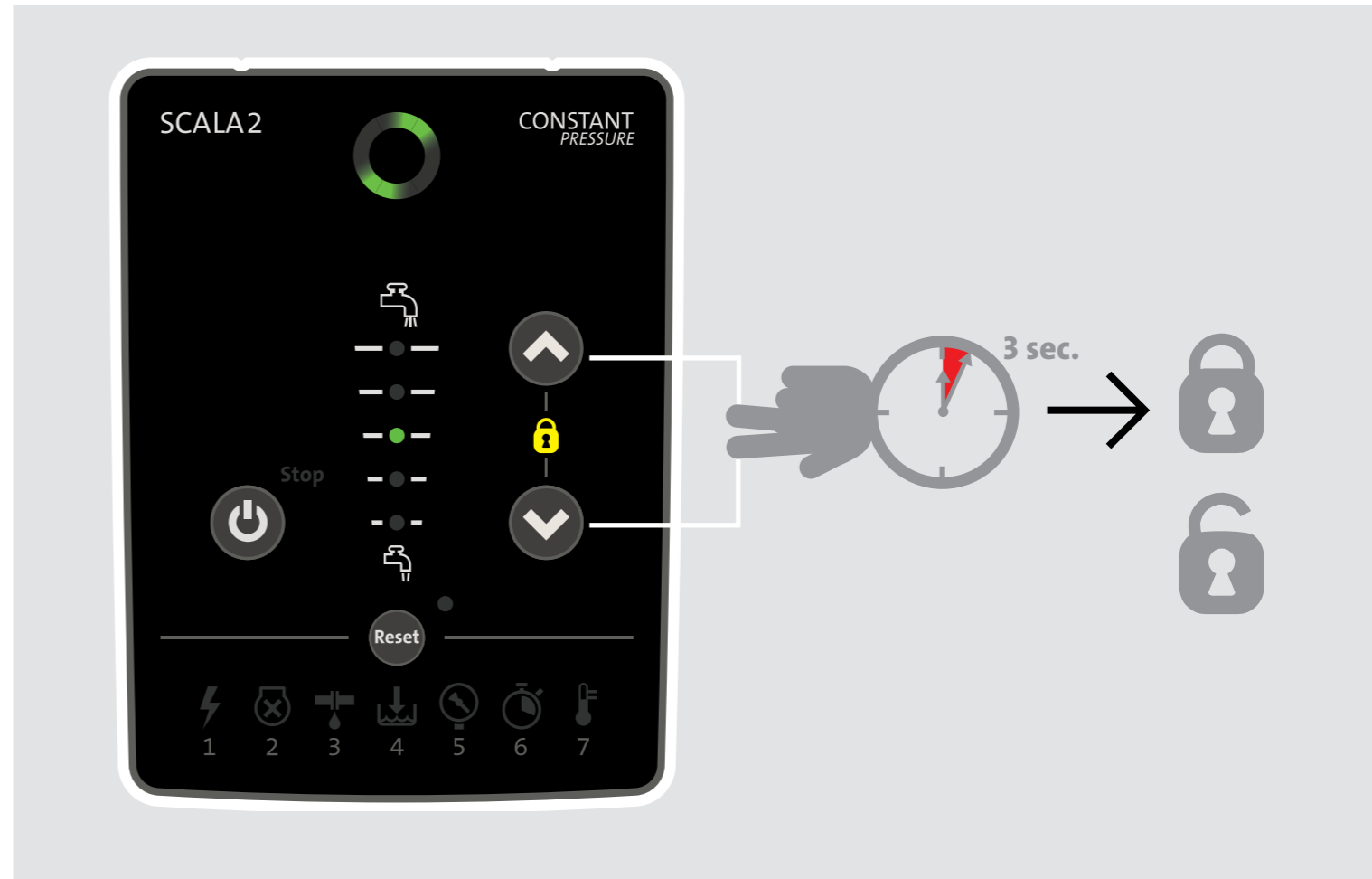
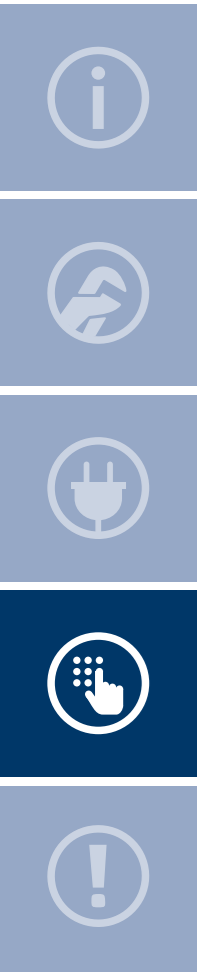

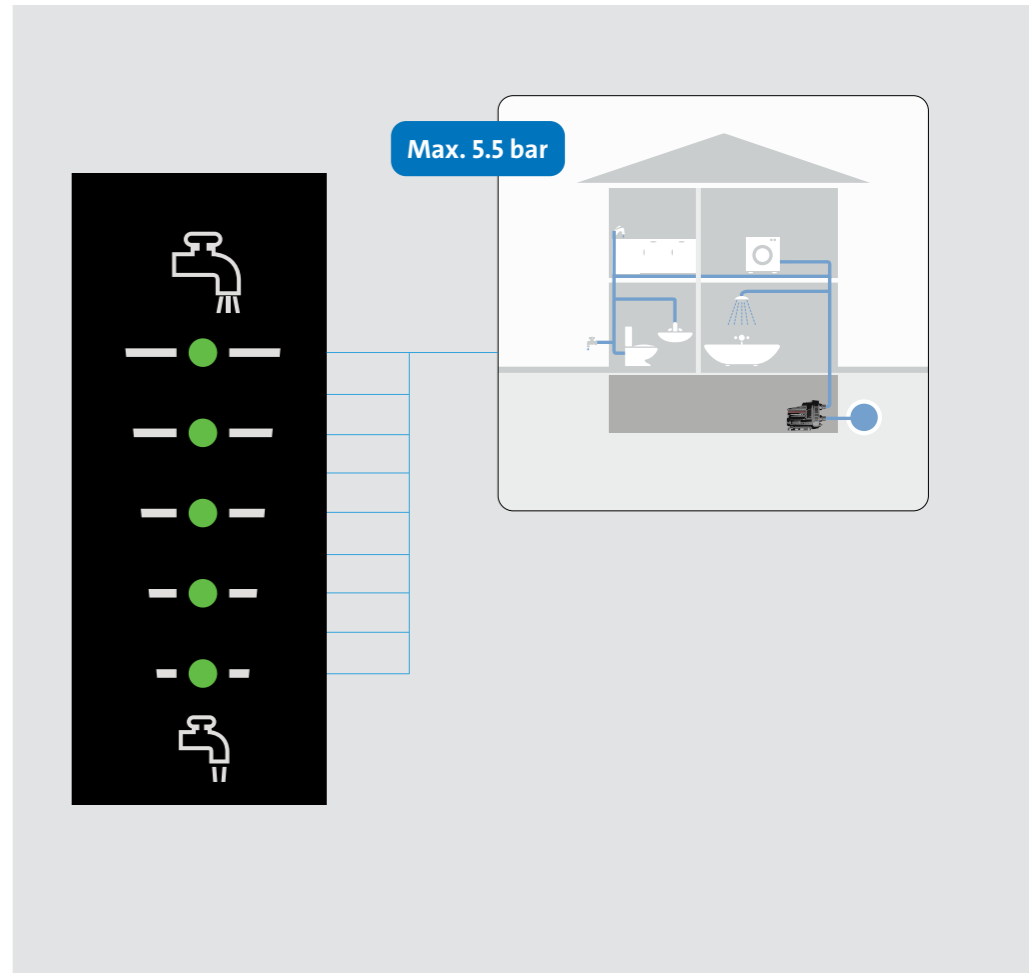
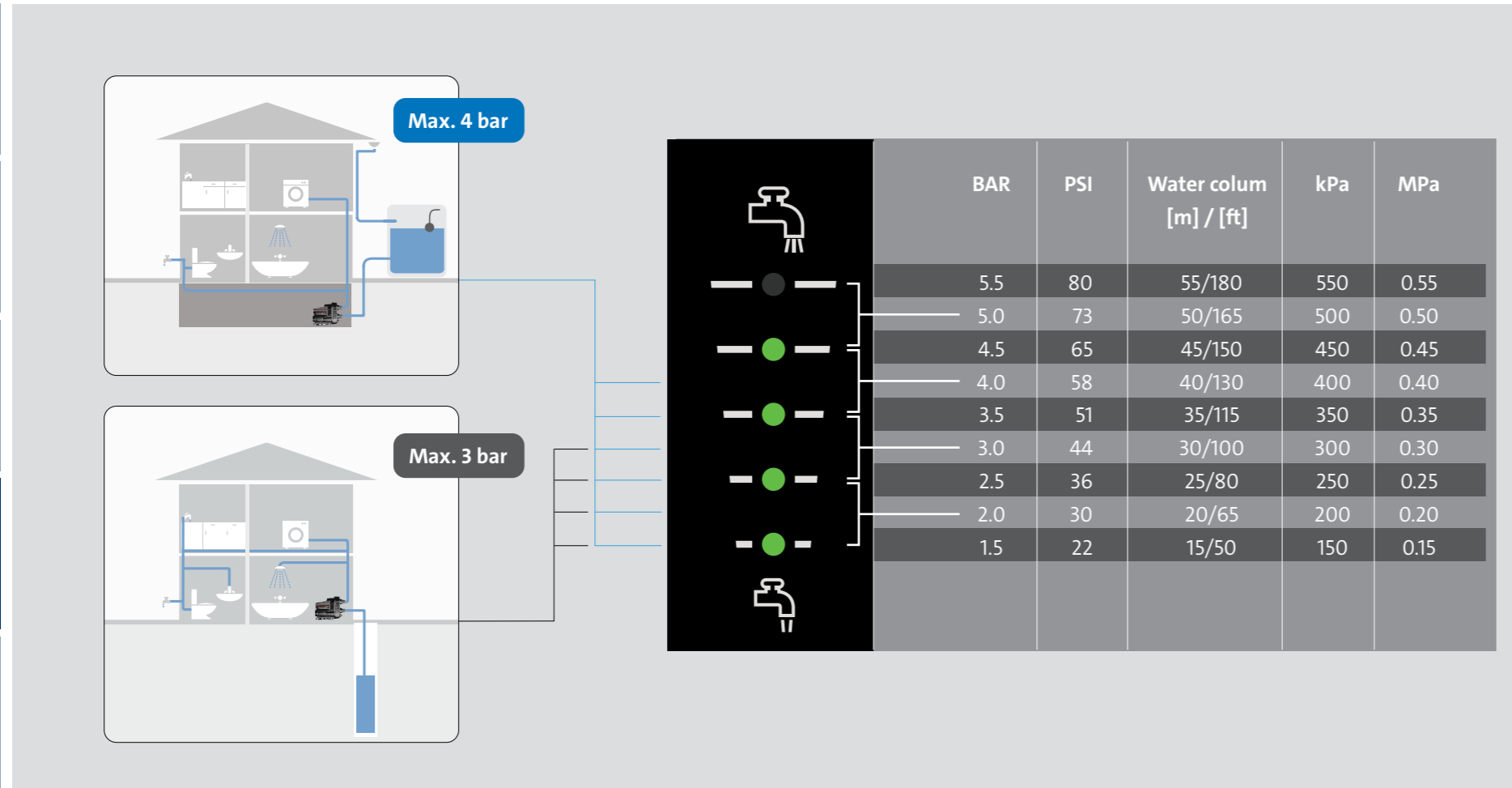
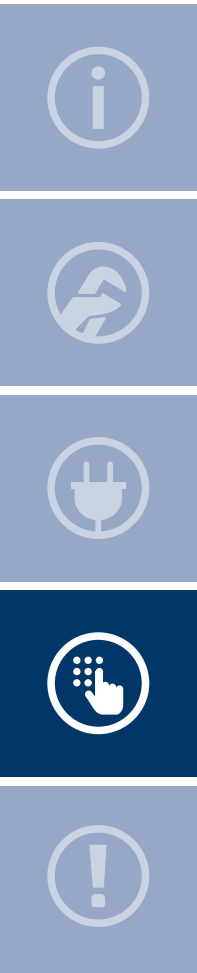

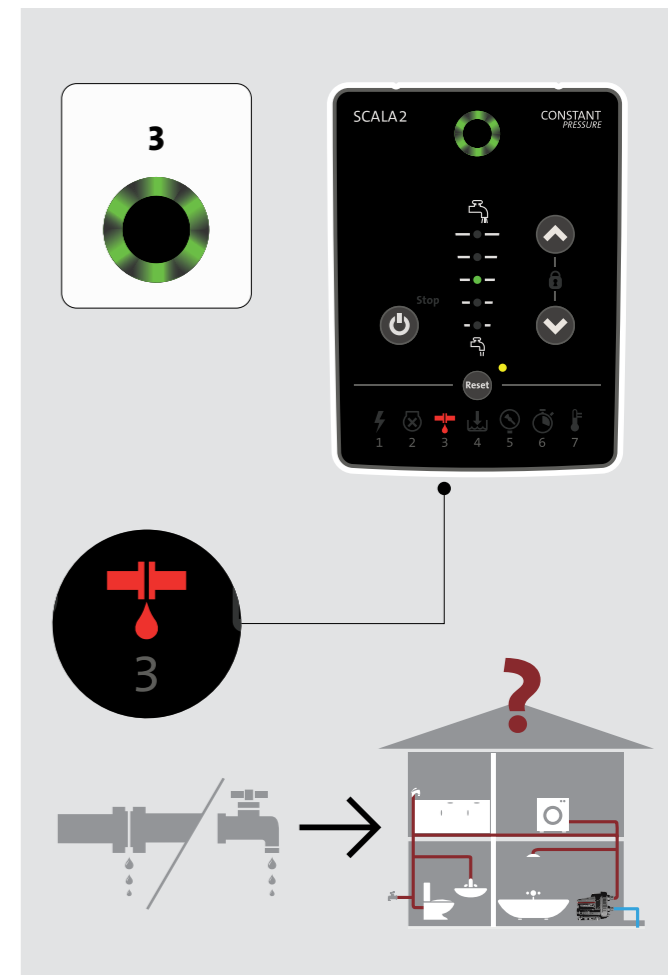
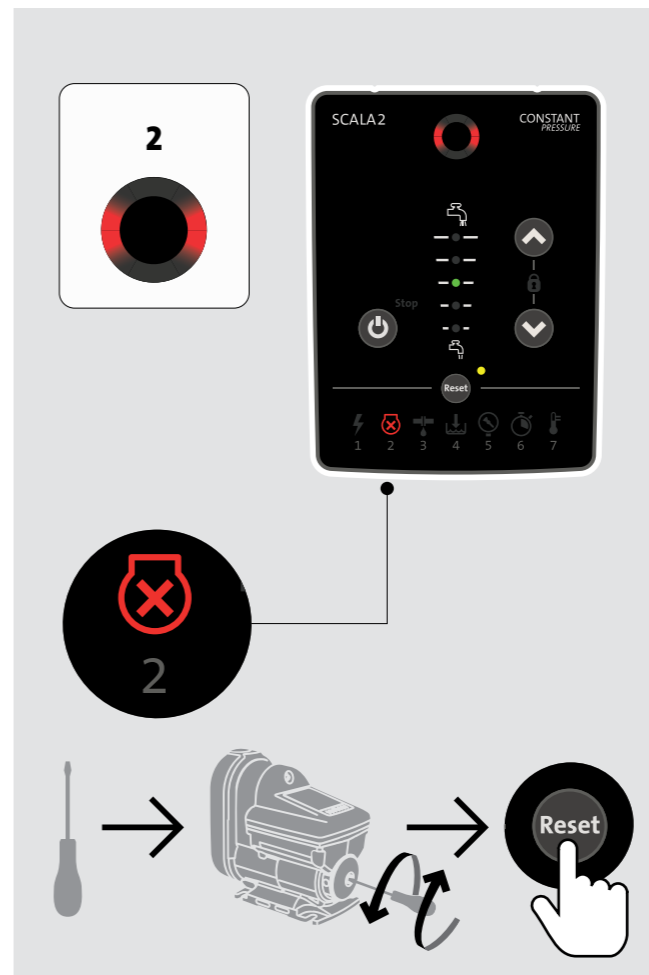
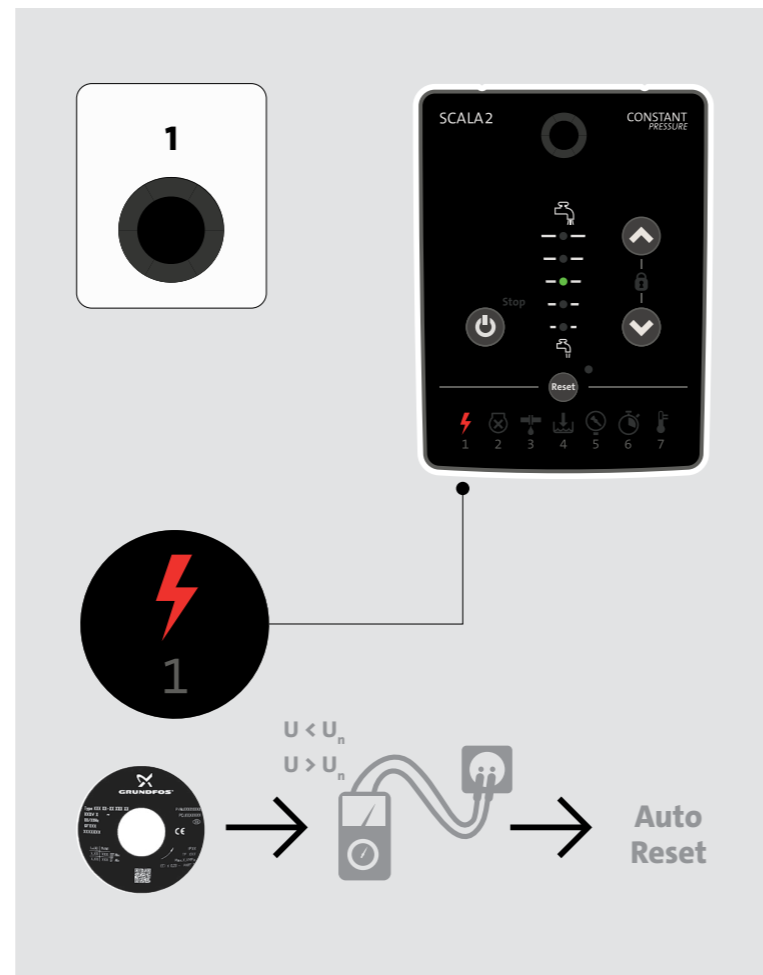
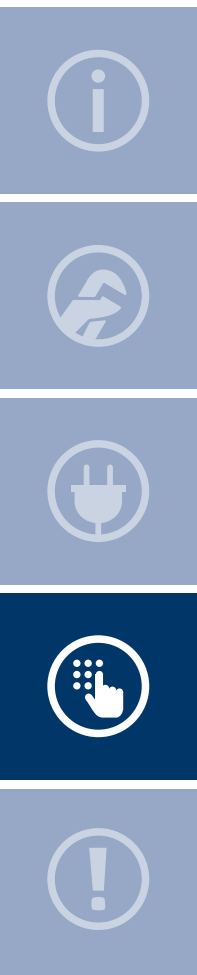

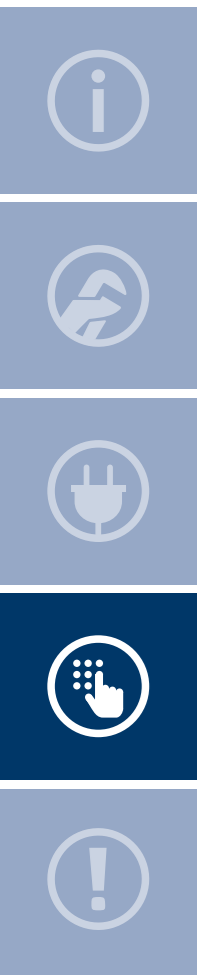

4

SCALA2 CONSTANT PRESSURE

4

Diagram illustrating step 4: A red arrow points down into a water tank, indicating a specific action related to the water level or flow.

5

SCALA2 CONSTANT PRESSURE

5

Diagram illustrating step 5: A red key icon is shown, indicating a key function or setting. Below, a lock icon is shown being unlocked, followed by an equals sign and a factory icon, suggesting a factory reset or mode.

6

SCALA2 CONSTANT PRESSURE

6

30 min.

Diagram illustrating step 6: A red stopwatch icon is shown, indicating a 30-minute timer. Below, a faucet icon is shown with water flowing, followed by an arrow pointing to a 30-minute timer icon.

7

SCALA2 CONSTANT PRESSURE

7

Diagram illustrating step 7: A red thermometer icon is shown, indicating a temperature-related function. Below, a thermometer icon is shown next to a pump unit, suggesting a temperature control or monitoring function.



net.grundfos.com/qr/i/98880508

98501666

ECM: 1361638 | 02.2023

GRUNDFOS Holding A/S
Poul Due Jensens Vej 7
DK-8850 Bjerringbro
Tel: +45 87 50 14 00
www.grundfos.com

GRUNDFOS 

The name Grundfos, the Grundfos logo are registered trademarks owned by Grundfos Holding A/S or Grundfos A/S, Denmark. All rights reserved worldwide.