

1312.0050

Line 1312.0050

Ø 50 mm vertical drain



Specifications

ITEM NUMBER 1312.0050	GTIN NUMBER 5707692007922	WEIGHT INCLUDING PACKAGING 440 g
WEIGHT EXCLUDING PACKAGING 400 g	MATERIAL Plastic (PP)	USAGE Line drain
BARRIER Without	GASKET EPDM	CAPACITY 1.7 l/s
SIDE INLET Without	FITS DRAIN UNIT 1001, 1002, 1003, 1004, 1100, 3002, 3004, 5002, 5003	

FITTING HEIGHTS - LINE FAUCETS 1001, 1002, 1003, 1004

Ø	Outlet direction	300	600	700	800	900	1000	1200
Ø 50 mm	Vertical	108 mm		113 mm	114 mm	115 mm	116 mm	118 mm

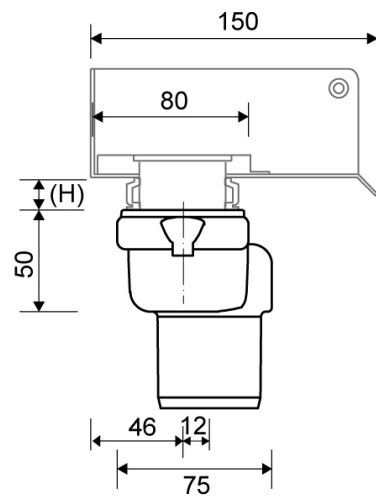
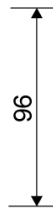
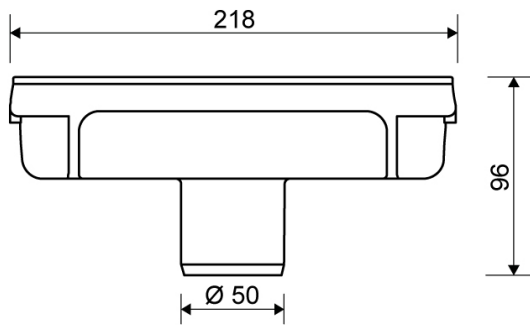

1312.0050

Products