

# MEISTERSTÜCK CONODUO 1 RIGHT CORNER INSTALLATION (2-SIDED)

- bath made of high-quality steel enamel with enamelled panelling on two sides
- specially designed for corner installation
- available as right or left-hand model
- with exclusive easy-clean finish
- straightlined, purist design
- enamelled waste cover and overflow knob integrated in the bath design (also available with filling function)
- made of KALDEWEI steel enamel
- designed by Sottsass Associati

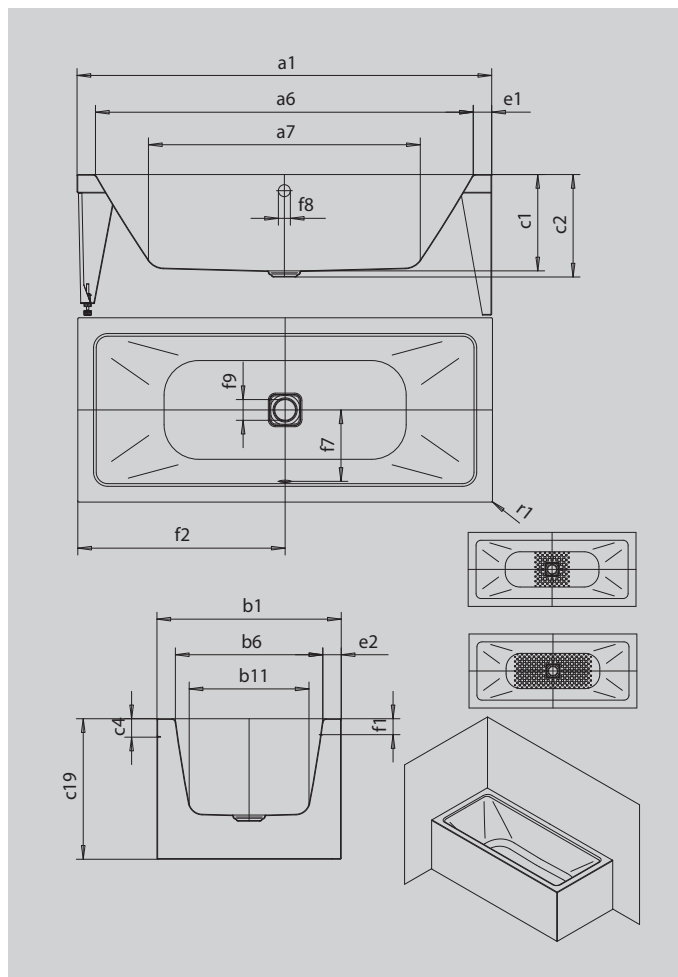

Similar illustration



Model		1712
External length	a <sub>1</sub>	1700 mm
Internal length (top)	a <sub>6</sub>	1540 mm
Internal length (bottom)	a <sub>7</sub>	1080 mm
External width	b <sub>1</sub>	750 mm
Internal width (top)	b <sub>6</sub>	590 mm
Internal width (bottom)	b <sub>11</sub>	470 mm
Depth inside	c <sub>1</sub>	420 mm
Depth incl. waste hole	c <sub>2</sub>	445 mm
Height of rim	c <sub>1</sub>	80 mm
Height of bath	c <sub>19</sub>	610 mm
Width of rim (foot end; long side)	e <sub>1</sub> ; e <sub>2</sub>	80; 80 mm
Distance top edge to centre of overflow hole	f <sub>1</sub>	70 mm
Distance bath edge to centre of waste hole	f <sub>2</sub>	850 mm
Distance centre of waste hole to centre of overflow hole	f <sub>7</sub>	285 mm
Diameter of overflow hole	f <sub>8</sub>	Ø 52 mm
Diameter of waste hole	f <sub>9</sub>	Ø 90 mm
External radius	r <sub>1</sub>	5 mm
Water volume		122 l
Waste connection diameter		Ø 40/50
Fill fitting connection		1/2"
Net weight		100 kg
Anti-slip		356 x 356 mm
Full anti-slip		788 x 356 mm